

Low bed trailers <3,5t

Inertia braking

VPR / CP / GPA Ranges

VPR 130 / VPR 200 / VPR 250 / VPR 350 / VP 35

CP 35 / CP 35 PB / CP 35 SN / CP 35 TF / GPA 250 / GPA 350







english



GOURDON

VP / VPR RANGE Guaranteed comfort and durability.

EQUIPMENT		VPR 130	VPR 200 VPR250	VPR 350 VP35
HITCH 	Classic drawbar (manual adjustment of the coupling height)	●	●	●
	Gourdon® hydraulic drawbar (hydraulic adjustment of the coupling height)	–	○	○
	BNA coupling ring	●	●	●
	Ø50mm ball coupling (delivered in addition to standard BNA ring)	○	○	○
	DIN40 coupling ring for Rockinger hook (delivered in add. to standard BNA ring)	○	○	○
	Heavy-duty steel Jockey wheel with large section crutch	●	●	●
UNDER CARRIAGE 	Heavy-duty axles and tyres	●	●	●
	Lateral spare wheel	○	○	○
	Suspension of axles by torsion	●	●	●
	Inertia braking of each axle	●	●	●
BODY / LIGHTING 	CE homologation	●	●	●
	Steel front panel	–	–	○
	One-piece robust framework	●	●	●
	On-demand RAL color (special painting applied in factory)	○	○	○
	Floor made of treated solid wood	●	●	●
	Floor made of composite material	–	–	○
	One-piece mudguards made of durable steel	●	●	●
	Waterproof document case	○	○	○
	Set of electric wires protected in steel tube (7/13 pins with adapter)	●	●	●
LED lights	○	○	○	
LOADING 	Rear ramps assisted by springs	–	●	●
	Wood + steel ramps , adjustable in spacing	●	●	●
	Aluminium ramps	–	○	○
	Automatic crutches at descent of the ramps	●	●	●
	Adjustable stop bolted on the sides	–	○	○
	Safety chocks for composite floor	–	–	○
	4 EC stowage rings	–	●	●
	Kit of 2 stowage chains with hooks and tensioners	○	○	○

● standard ○ option – not available

see page 3
for technical data

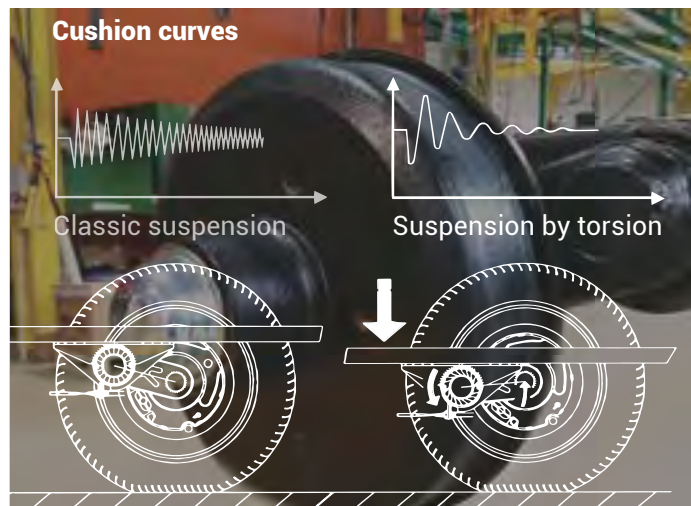
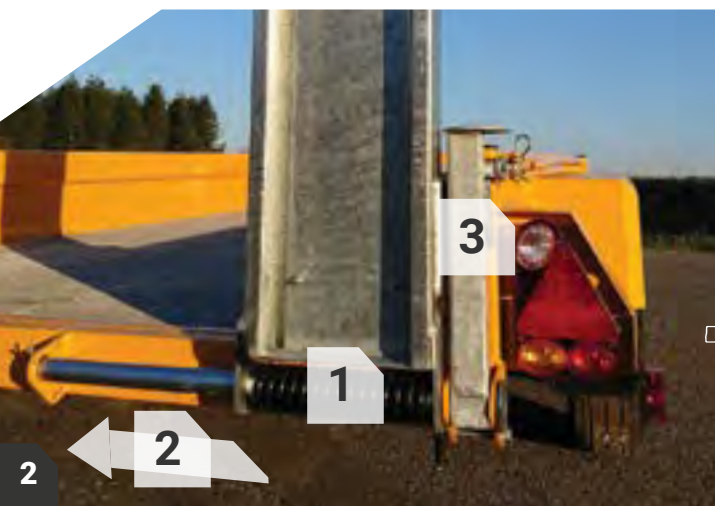

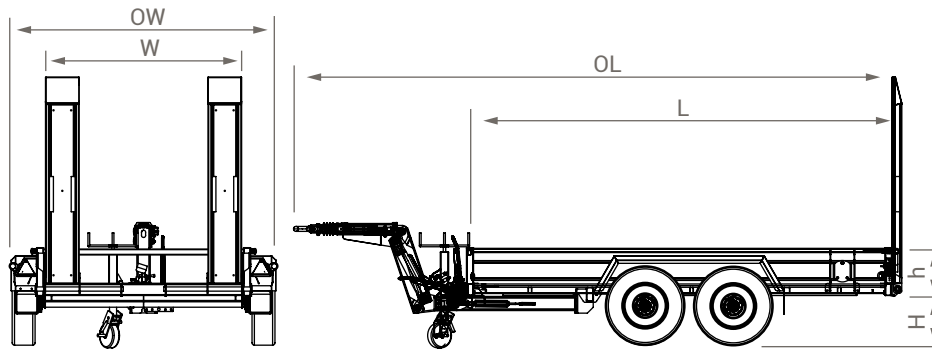

TECHNICAL DATA

Type	GW ¹ kg	PL ² kg	In-use dimensions				Overall dimensions ³		Ramps			Tyres
			L mm	W mm	H mm	h mm	OL mm	OW mm	length mm	width mm	min. spacing mm	
VPR130	1300	1000	1760	1000	425	200	3350	1590	1800	280	400	185x14
VPR200	2100	1500	2600	1400	460	300	4250	1950	1800	280	400	185/70R13
VPR250	2500	1940	3100	1500	470	300	4650	2050	1800	280	400	185x14
VPR350	3500	2750	3600	1700	530	300	5033	2250	1800	280	400	195X14
VP 35	3500	2680	3600	1900	530	300	5033	2450	1800	280	400	195X14
CP 35	3500	2800	3400	1650	520	260	4960	2250	1500	280	350	195x14
CP 35 PB ⁴	3500	2800	3600	1700	530	260	5033	2270	1500	280	400	195x14
CP 35 SN ⁵	3500	2800	3400	1650	450	260	4880	2250	1500	280	350	195x14
CP 35 TF ⁶	3500	2800	3400	1650	450	260	4880	2250	1500	280	350	195x14
GPA 250	2500	1900	3100	1500	510	260	5033	2070	1800	300	400	185x14
GPA 350	3500	2800	3600	1700	530	260	5033	2270	1800	300	400	195x14

¹ Gross weight

² Payload

³ With Gourdon[®] hydraulic drawbar

⁴ Wood floor

⁵ Special lifts

⁶ Fixed drawbar







RAMPS

SUSPENSION
BY TORSION

STOWAGE
SAFETY

JOCKEY WHEEL

EQUIPMENT		CP 35	CP 35 PB	CP 35 SN	CP 35 TF
HITCH 	Fixed drawbar	--	--	--	●
	Classic drawbar (manual adjustment of the coupling height)	●	●	●	-
	Gourdon® hydraulic drawbar ¹	○	○	○	-
	BNA coupling ring	●	●	●	●
	Ø50mm ball coupling ²	○	○	○	○
	DIN40 coupling ring for Rockinger hook ²	○	○	○	○
	Crutch with resting sole	●	●	●	●
	Heavy-duty steel Jockey wheel with large section crutch	○	○	○	○
UNDER CARRIAGE 	Heavy-duty axles and tyres	●	●	●	●
	Lateral spare wheel	○	○	○	○
	Suspension of axles by compression	●	●	●	●
	Inertia braking of each axle	●	●	●	●
BODY / LIGHTING 	CE homologation	●	●	●	●
	One-piece robust framework	●	●	●	●
	On-demand RAL color (special painting applied in factory)	○	○	○	○
	Anti-slip metallic floor (sheeted metal)	●	-	●	●
	Floor made of treated solid wood	-	●	-	-
	Floor made of composite material	-	○	-	-
	One-piece mudguards made of durable steel	●	●	●	●
	Waterproof document case	○	○	○	○
	Set of electric wires protected in steel tube	●	●	●	●
	LED lights	○	○	○	○
LOADING 	Wood + steel ramps, adjustable in spacing	●	●	●	●
	Aluminium ramps	○	○	○	○
	Automatic crutches at descent of the ramps	●	●	-	●
	Adjustable stop bolted on sides	○	○	○	○
	Safety chocks for composite floor	-	○	-	-
	4 EC stowage rings	●	●	●	●
	Kit of 2 stowage chains with hooks and tensioners	○	○	○	○

● standard ○ option - not available

¹ hydraulic adjustment of the coupling height

² delivered in addition to standard BNA ring

³ 7/13 pins with adapter

see page 3
for technical data



CP 35

Low bed trailer available with a metallic or wooden floor



CP 35 SN

The alternative for lifts, a cutback for a smooth loading

- 1 assisted by springs :
lifting assistance + fall brake
- 2 adjustable in spacing
- 3 automatic crutches at descent

Guaranteed driving flexibility and durability.
Eased manoeuvres. Optimized maintenance.

Kit of 2 stowage chains with hooks and tensioners (option)
Adjustable stop (option)

Stowage rings (industrial shackles)

Made of steel with a large section crutch



VPR 350
The best of low bed trailers

3 hours of time, 3 sites started, with 3 different equipment.

Start-up your sites with efficiency.
Progress on your sites and forget about transport matters.



7h00
Delivery of a mini-excavator at the construction site of an industrial building.



8h00
Unloading of an industrial forklift for a machinery renting company.



9h00
Arrival at a biogas plant for a compaction work.

Gourdon® hydraulic drawbar

Ergonomy, performance and security reunited.

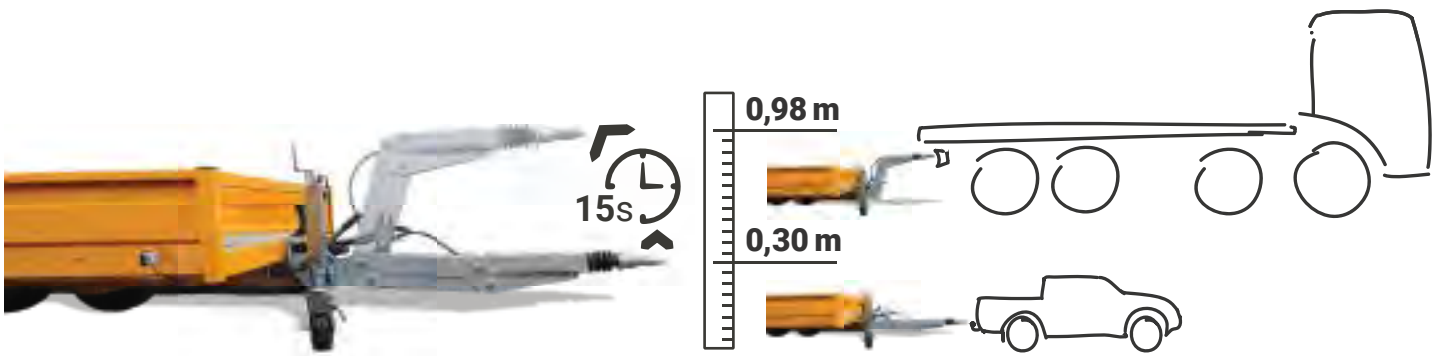

ERGONOMY

Effortless and accurate coupling.





PERFORMANCE, ROBUSTNESS

From a compact vehicle to a heavy one ? Have it done in a few seconds.

Our goal : **simplify your transport process to improve your productivity and security.**

SECURITY

Thanks to its fast hydraulic adjustment device securing a trim parallel to the ground, the Gourdon® hydraulic drawbar ensures an optimal braking to work in the best conditions.

ÉQUIPEMENTS		GPA 250	GPA 350
HITCH 	Classic drawbar (manual adjustment of the coupling height)	●	●
	Gourdon® hydraulic drawbar (hydraulic adjustment of the coupling height)	○	○
	BNA coupling ring	●	●
	Ø50mm ball coupling (delivered in addition to standard BNA ring)	○	○
	DIN40 coupling ring for Rockinger hook (delivered in add. to standard BNA ring)	○	○
	Heavy-duty steel Jockey wheel with large section crutch	●	●
UNDER CARRIAGE 	Heavy-duty axles and tyres	●	●
	Lateral spare wheel	○	○
	Suspension of axles by compression	●	●
	Inertia braking of each axle	●	●
BODY / LIGHTING 	CE homologation	●	●
	One-piece robust and galvanized framework	●	●
	Floor made of treated solid wood	●	●
	Floor made of composite material	-	○
	One-piece galvanized mudguards made of durable steel	●	●
	Waterproof document case	○	○
	Set of electric wires protected in steel tube (7/13 pins with adapter)	●	●
	LED lights	○	○
LOADING 	Aluminium ramps	●	●
	Automatic crutches at descent of the ramps	●	●
	Adjustable stop bolted on the sides	○	○
	Safety chocks for composite floor	-	○
	4 EC stowage rings	●	●
	Kit of 2 stowage chains with hooks and tensioners	○	○

● standard ○ option - not available

see page 3
for technical data



ALUMINIUM RAMPS
standard



FLOOR MADE OF TREATED SOLID WOOD

standard,
as for the VP / VPR range

GPA 350

the galvanized low bed trailer

GOURDON / Brochure_VP_VPR_CP_CPSN_GPA_202002. The technical characteristics and the engravings are given as an indication, without obligation on our part and are therefore subject to change without notice. Non-contractual photo. Subject to typographical errors.



GOURDON FRÈRES, PLC with a share capital of 310 000€

2693 route de Geaune, FR – 40800 AIRE SUR L'ADOUR

SIREN : 340 806 439 – RCS MONT DE MARSAN

Phone: +33 (0) 5 58 71 65 83

Mail: contact@remorques-gourdon.com

Web: www.remorques-gourdon.com

Find us on :

